

New-Generation PXF Series

Digital Temperature Controller

Exceeding Your Expectations...

- ✓ High Speed and High Accuracy
- ✓ Multi-Drop Master Function
- ✓ Universal Input



MSA CONTROL - (11) 3961-1171 - comercial@msacontrol.com.br

Superior Versatility and Flexibility for a Wide Range of Applications



Multi-Functional to Suit Your Needs

In addition to 9 types of temperature control functions including on-off control, heating/cooling control, and 2-degrees-of-freedom PID, useful functions such as multi-drop control using RS-485 network and simple watt-hour monitoring are available. All these features make PXF practical for any applications.

*For details of each functions, see pages 4-7.

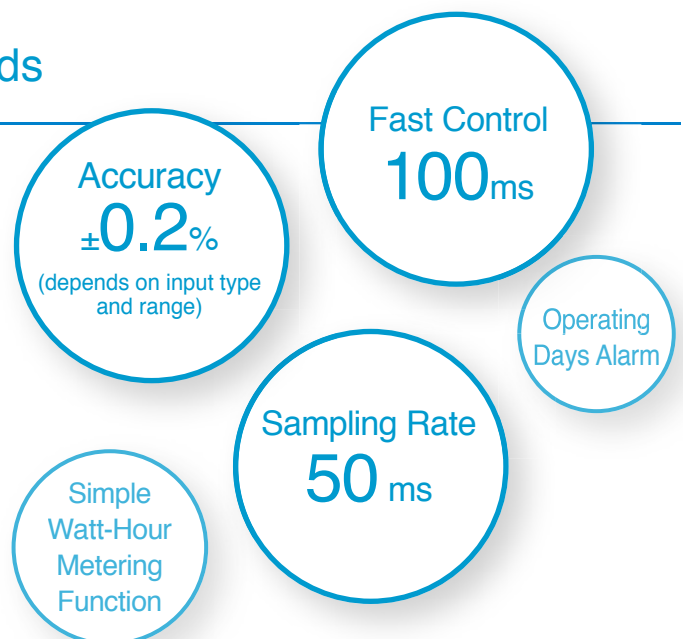

RS-485 Communication (option)

SV can be transmitted to multi-PXFs through communication. Synchronous temperature-rise control is available in combination with 2-degrees-of-freedom PID.

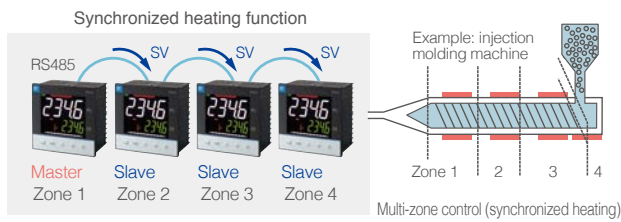

Universal Input

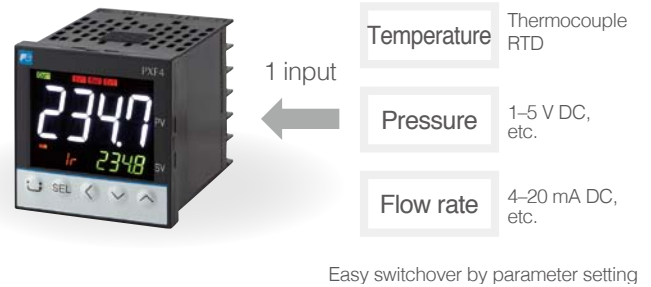

Tallest PV Characters in the Industry

Bright and clear white PV display for optimal viewing



Compact Design

With only 58-mm depth, compact enough to be installed on small equipment



Size Selection

3 different sizes, with a depth of 58 mm



Parameter Setting Available on PC

Parameter loader software is download free from our website. Optional USB cable enables PXF to be connected to and powered from PC.



Parameter setting is available using the front keys or a PC with Fuji Electric's loader software.

Standard Functions

1 On/off Control Simple and Basic Control

When process value (PV) is below the set value (SV), PXF turns on the output to energize the heater, and vice versa. In this way, PXF keeps the temperature constant by turning the output on and off based on the SV as a threshold.

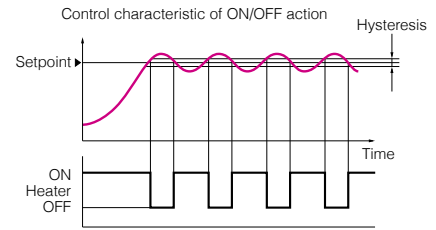

2 PID Control with Auto Tuning Typical Control Based on PID Theory

* Overshoot may occur due to external disturbance.

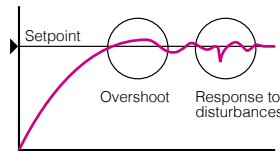

Molding Machine

Start/stop of auto tuning can be commanded externally.

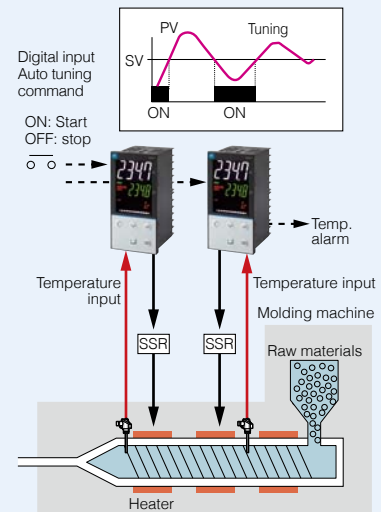

PID Auto Tuning

The controller calculates optimal PID parameters. PXF has 2 types of auto-tuning functions; the standard type (auto-tuning with SV used as reference) and the low SV type (auto-tuning with the value 10% below SV used as reference).

(a) Standard type

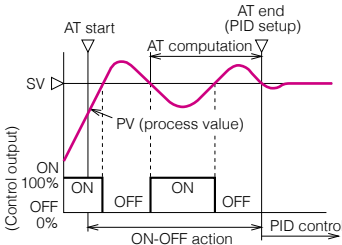

(b) Low-PV type

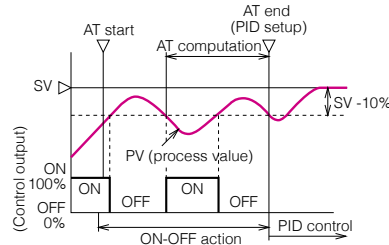

3 Fuzzy Control with Auto Tuning Suppresses Overshoot by Fuzzy Calculation

By monitoring PV, PXF suppresses overshoot without lengthening startup time. At the same time, it can quickly deal with external disturbances.

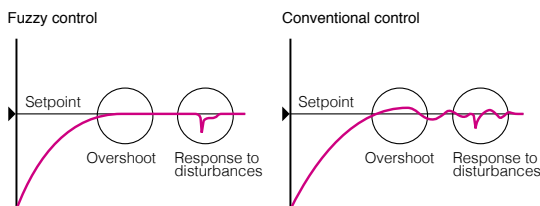

4 2-Degree-of-Freedom PID with Auto Tuning Combined Method for Stable Control

Suppresses overshoot and undershoot occurs at startup or at SV change, or by external disturbances.

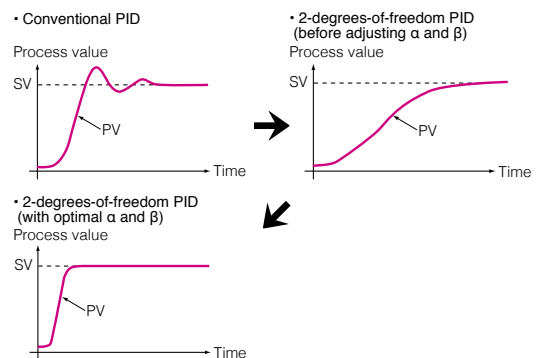

5 Open-Loop Supported PID2 Control Suppresses Overshoot

Reduces overshoot in the processes where the controlled equipment is power cycled.

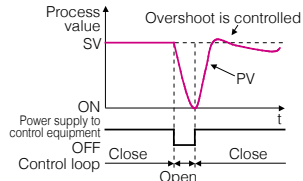

6 Self Tuning Control Auto-Tuned PID for Changing Temperature

At power up, SV change, or during external disturbance, tuning is made automatically so that the PID parameters are re-optimized.

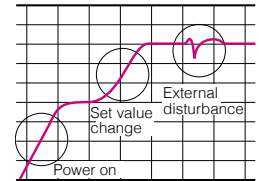

*For some objects of control, PID values cannot be optimized.

7 Simple Program Control (Ramp Soak Function) Up to 64 Steps

PXF automatically changes SV to the preset values at preset times. You can set up to 64 steps and 15 types of operation patterns. For example, when you bake four kinds of bread, you can divide 64 steps into four patterns to set suitable temperature for each bread.

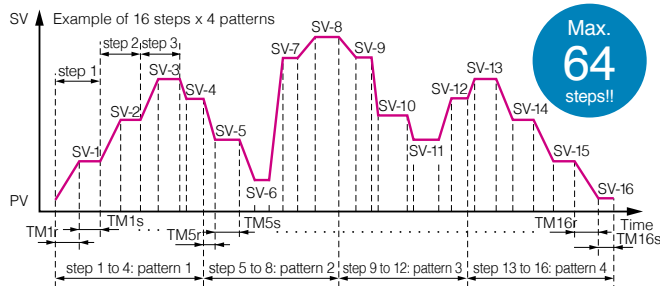

- Basic functions
 - [h · min] or [min · s]
 - Guarantee soak
 - Repeat action
 - PV start
 - Delay start
 - Power restoring function

- Operation

You can start/stop/suspend the operation using a user key, parameter setting, digital input, or communication.

- Number of steps and patterns

Steps	Patterns
64	1
32	2
16	4
8	8

Controlling Temperature Gradient of Furnace by heating patterns

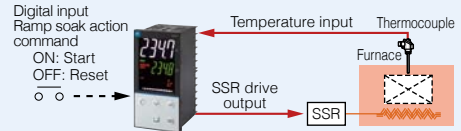

Ramp Soak Function

Temperature rise/fall pattern is controlled by setting a heat pattern having a gradient. You can externally start or reset the pattern.

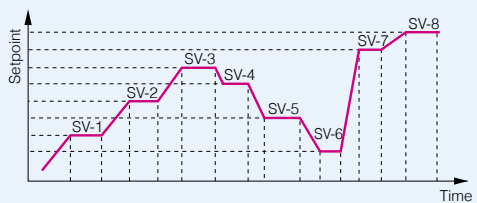

Optional Functions

1 Heating and Cooling Control with Dual Output

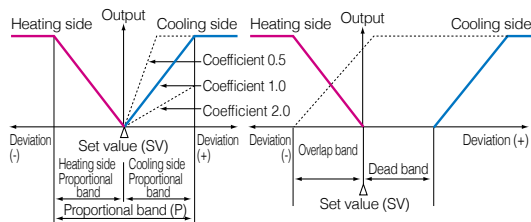

* For the cooling side proportional band, set a coefficient with respect to the heating side proportional band. (Works as on-off control if coefficient is zero.)

Energy Savings in Livestock Barns

Both heating and cooling are controlled with one temperature controller using its two control outputs. Power consumption can be curbed by controlling a cooling fan motor with inverter.

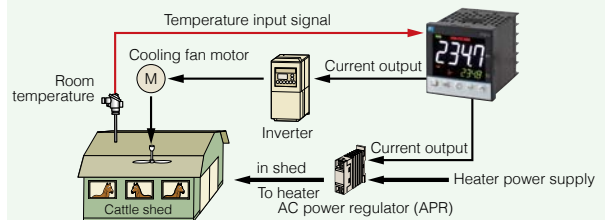

2 Motorized Valve Control Valve Opening/Closing is Available

- Position feedback control based on motorized valve position signal
- Servo control without valve position signal



Heating/Cooling Control of Air Conditioner

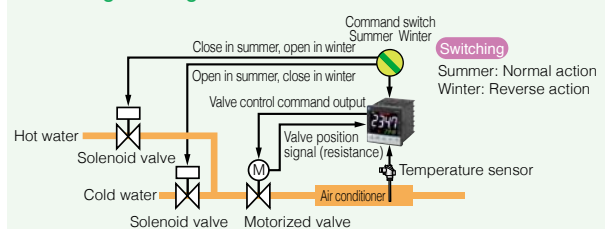

Variety of Functions

Expanding the Uses of Temperature Controllers and Improve the User Experience

Standard Functions

1 SV and PID selection Easy Switching Among 8 Presets

This enables optimum PID setting for changing process, materials, or PV. You can perform SV selection only, PID selection only, or PID selection according to PV.

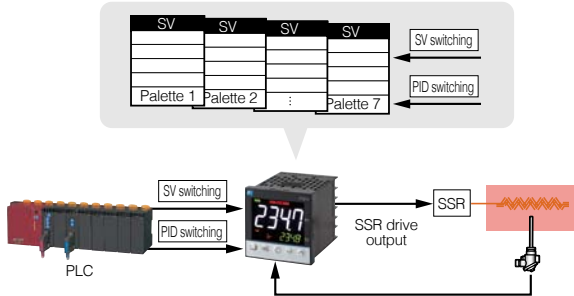

2 Soft Start Saves Energy at Startup

Prevents the output being maximum when turning on the equipment (including the temperature controller). This is useful for suppressing the load at equipment startup.

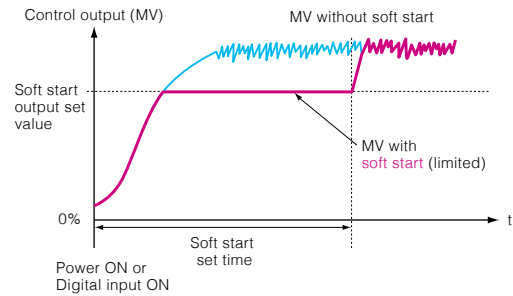

3 Simple Watt-Hour Metering Function Tells You the Energy Consumption

If you use an optional current transformer (See page 10). Approximate monitoring is also available without CT.

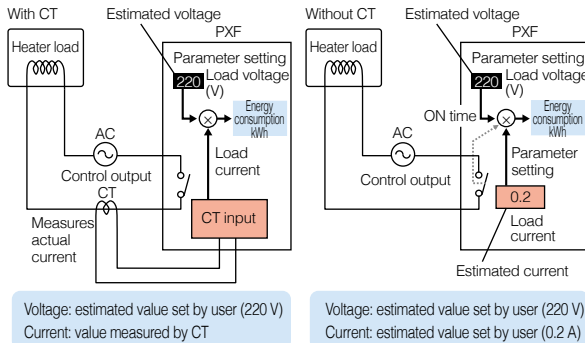

4 Operating Days Alarm For Well-Timed Maintenance

Indicator or alarm output alert you when the number of days operated has reached the limit you set.

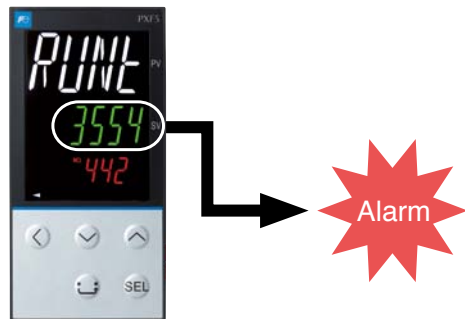

Optional Functions

1 Re-transmission Output Temperature Signals to External Devices

Cost savings achieved by eliminating the need for an extra temperature sensor

- Output signal : 0–20 mA DC, 4–20 mA DC, 0–5 V DC, 1–5 V DC, 0–10 V DC, or 2–10 V DC
- Process value (PV), set value (SV), control output (MV), or PV-SV (DV)

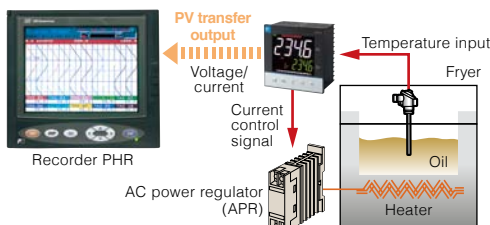

2 Heater Burnout Alarm Quickly Informs You a Failure

- A current transformer (CT) is required.
- The power supply voltage and the alarm action point must be configured beforehand.

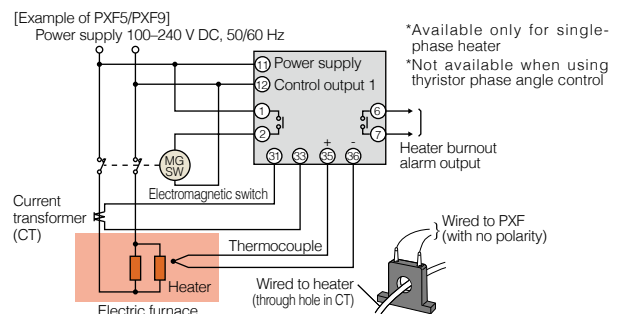

3 Alarm Output Up to 5 Alarms (PXF4: up to 3)

	Alarm type	Action diagram
Absolute value alarm	Upper limit absolute value	
	Lower limit absolute value	
	Upper limit absolute value (with hold)	
	Lower limit absolute value (with hold)	
Deviation alarm	Upper limit deviation	
	Lower limit deviation	
	Upper and lower limits deviation	
	Upper limit deviation (with hold)	
	Lower limit deviation (with hold)	
	Upper and lower limits deviation (with hold)	
Range alarm	Range upper and lower limits deviation (ALM1/2 independent operation)	
	Range upper and lower limits absolute value	
	Range upper and lower limits deviation	
	Range upper limit absolute value and lower limit deviation	
	Range upper limit deviation and lower limit absolute value	

4 Digital Input SV Can be Switched Externally

SV change, AT start, timer startup, program selection, start/stop/reset, PID changeover, etc.

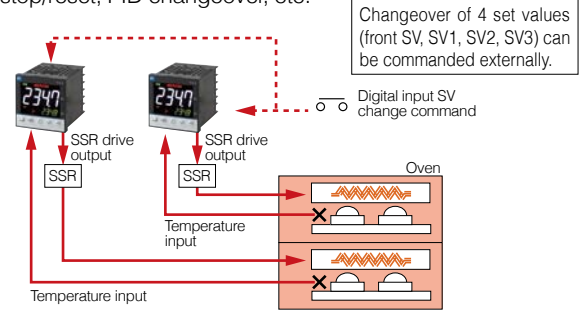

5 Remote SV Input SV Can be Configured Externally

- Input signal: 0-5 V DC, 1-5 V DC, 0-10 V DC, 0-20 mA DC, or 4-20 mA DC
- Input impedance: About 1 MΩ

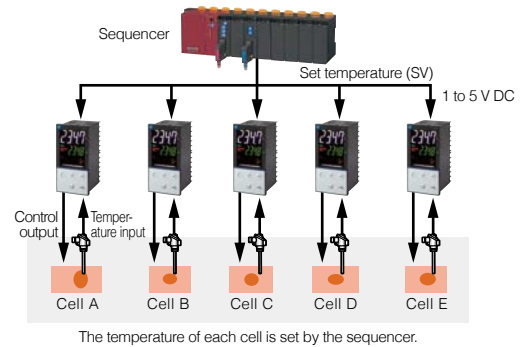

6 RS-485 Communication

- User address mapping function
Users can create a list of necessary parameters (max. 32 words) for quick data acquisition on that data set.
Communication speed: max. 115.2 kbps

Address	Parameter
30001	PV
30002	SV(Read)
30003	DV
30004	MV1
⋮	⋮
40003	SV(Write)
40004	STBY
40005	AT
40006	P
40007	I
40008	D
⋮	⋮

Max. 32 words

Address	Parameter
30001	PV
30002	SV(Read)
40003	SV(Write)
30004	MV1
40006	P
40007	I
40008	D
⋮	⋮
-	-
-	-



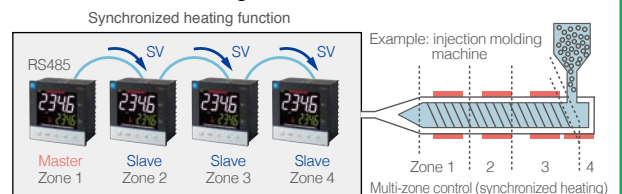

- Multidrop master function
Synchronous temperature-rise control is available in combination with 2-degrees-of-freedom PID.

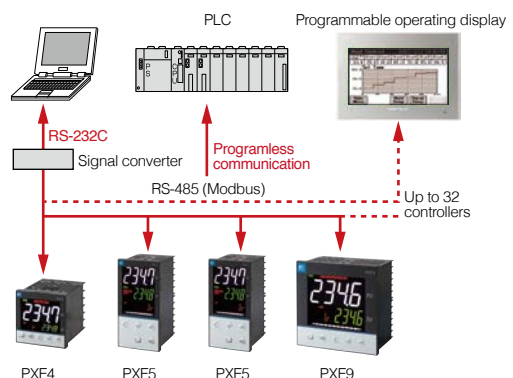

- Parameter copy function
Parameter values can be copied to multiple PXFs simultaneously.
- Communication with PC, programmable operation display, or PLC



Product Lineup

Model		PXF4	PXF5	PXF9
Appearance				
Front panel size (W x H)		48 x 48 mm	48 x 96 mm	96 x 96 mm
Depth		58 mm		
Display digits		4-digit (PV and SV)		
Character height (PV)		15.3 mm	18.1 mm	26 mm
Indication accuracy		RTD input: $\pm 0.2\%$ of indication value ± 1 digit or $\pm 0.8^\circ\text{C} \pm 1$ digit, whichever is larger Thermocouple input: $\pm 0.3\% \pm 1$ digit of indicated value or $\pm 1^\circ\text{C} \pm 1$ digit, whichever is larger Voltage input and current input: $\pm 0.3\% \text{FS} \pm 1$ digit		
Sampling rate		50 ms		
Input signal	Option	Process value input	Universal input (RTD, thermocouple, voltage/current)	
		Remote SV input	Voltage/current	
		Current transformer (CT) input	Dedicated CT (1 to 100 A)	
		Motorized valve position input	-	100 Ω to 2.5k Ω (3-wire)
		Digital input (DI)	1 (Motorized valve control version: up to 3)	Up to 3
Output signal	Control output	Relay contact	●	
		SSR/SSC drive output	●	
		Current output (linear)	●	
		Voltage output (linear)	●	
	Option	Motorized valve control output	●	
		Analog re-transmission output (voltage)	●	
		Analog re-transmission output (current)	●	
		Heater burnout alarm output	●	
		Operating days alarm	●	
		Alarm/event contact output (DO)	Up to 3	Up to 5
Control method (*with auto tuning)		ON/OFF control	●	
		PID control*	●	
		Fuzzy control*	●	
		2-degrees-of-freedom PID control*	●	
		Open-loop supported PID2 control	●	
		Self tuning	●	
		Ramp soak function (simple program control)	Up to 64 steps	
	Option	Heating/cooling control*	●	
		Motorized valve control	●	
	Functions		Number of PV/PID patterns	Up to 8
SV/PID switchover			●	
Soft start			●	
Simple watt-hour metering			●	
Operating days			●	
Manual operation			●	
User key			●	
Communication	Option	Loader interface	●	
		RS-485 (Modbus)	●	
Power supply voltage	Option	100–240 V AC, 50/60 Hz	●	
		24 V DC/AC	●	
Power consumption		10 VA MAX.	13 VA MAX.	13 VA MAX.
Screw terminals		M3		

*Some functions are unavailable depending on the model. For more detail, please refer to the specifications on Page 14.

Outline Diagram

PXF4

Outer dimensions	Panel cutout
	<p>Panel cutout</p> <p>For close mounting in horizontal direction ("n" units) (Waterproof property is lost in this case)</p> <p>In horizontal close mounting where the packing cannot be used, PXF front panel does not meet NEMA 4X nor IP66.</p> <p>* Dimensions include coating thickness.</p>

PXF5

Outer dimensions	Panel cutout
	<p>Panel cutout</p> <p>For close mounting in horizontal direction ("n" units) (Waterproof property is lost in this case)</p> <p>In horizontal close mounting where the packing cannot be used, PXF front panel does not meet NEMA 4X nor IP66.</p> <p>* Dimensions include coating thickness.</p>

PXF9

Outer dimensions	Panel cutout
	<p>Panel cutout</p> <p>For close mounting in horizontal direction ("n" units) (Waterproof property is lost in this case)</p> <p>In horizontal close mounting where the packing cannot be used, PXF front panel does not meet NEMA 4X nor IP66.</p> <p>* Dimensions include coating thickness.</p>

Rear view

PXF4	PXF5	PXF9

Ordering Code

P X F

4	5	6	7	8	9	10	11	12	13
A			2	-				0	0

PXF4 Standard Type

Digit	Specifications	Code
1-4	Front panel size W x H 48 x 48mm	PXF4
5	—	A
6	Control output 1	
	Relay contact (SPST) *1	A
	Relay contact (SPDT) *1	B
	SSR drive output	C
	Current output	E
7	Control output 2	
	None	Y
	Relay contact (SPST)	A
	SSR drive output	C
	Current output	E
8	Revision code	2
	Alarm output	
	None	0
	1 point	1
	2 points	F
9	3 points	M
	2 points (independent common)	J
	Power supply voltage/instruction manual	
	100 to 240 V AC, Japanese & English	Y
	100 to 240 V AC, English	V
10	100 to 240 V AC, Chinese & English	W
	24 V AC/DC, Japanese & English	A
	24 V AC/DC, English	B
	24 V AC/DC, Chinese & English	D
	Option	
11	None	Y
	RS-485 Communication	M
	Digital input (DI1)	S
	RS-485 communication + Digital input (DI1)	V
	RS-485 communication + Remote SV input *2	K
12	RS-485 Communication + CT input *3	J
	—	00
13	—	00

*1: Not available for the 7th code "C", "E", "P", "R", "S". However, if you want to order the 6th code "A" (SPST relay contact for the control output 1) and the 7th code "R" or "S" (current/voltage re-transmission output for the control output 2), specify the model as follows:

PXF4AA[

R	S	P	C	E	A
---	---	---	---	---	---

]2-□□□02

*2: When using current for the remote SV input, add a 250-ohm resistor to the input terminal.

*3: When using the CT input for heater burnout alarm, add one alarm output for it in the 9th code.

PXF5 & PXF9 Standard Type

Digit	Specification	Code
1-4	Front panel size W x H 48 x 96 mm 96 x 96 mm	PXF5 PXF9
5	—	A
6	Control output 1	
	Relay contact (SPST)	A
	Relay contact (SPDT)	B
	SSR drive output	C
	Current output	E
7	Control output 2	
	None	Y
	Relay contact (SPST)	A
	SSR drive output	C
	Current output	E
8	Revision code	2
	Alarm output	
	None	0
	1 point	1
	2 points	F
9	3 points	M
	2 points (independent common)	J
	Power supply voltage/instruction manual	
	100 to 240 V AC, Japanese & English	Y
	100 to 240 V AC, English	V
10	100 to 240 V AC, Chinese & English	W
	24 V AC/DC, Japanese & English	A
	24 V AC/DC, English	B
	24 V AC/DC, Chinese & English	D
	Option	
11	None	Y
	RS-485 Communication	M
	Digital input (DI 1 and DI2)	T
	Remote SV input + Digital input (DI3) *1	H
	CT input + Digital input (DI1) *2	G
12	RS-485 communication + Digital input (DI1)	V
	RS-485 + Digital input (DI3, DI4, DI5) + Auxiliary alarm output (AL4, AL5)	C
	—	00
13	—	00

*1: When using current for the remote SV input, add a 250-ohm resistor to the input terminal.

*2: When using the CT input for heater burnout alarm, add one alarm output for it in the 9th code.

PXF4 Motorized Valve Control Type

Digit	Specifications	Code
1-4	Front panel size W x H 48 x 48mm	PXF4
5	—	A
6	Control output 1	
	Motorized valve control output (without PFB input)	T
7	Control output 2	
	None	Y
8	Revision code	2
	Alarm output	
9	None	0
	1 point	1
	2 points	F
	2 points (independent common)	J
	Power supply voltage/instruction manual	
10	100 to 240 V AC, Japanese & English	Y
	100 to 240 V AC, English	V
	100 to 240 V AC, Chinese & English	W
	24 V AC/DC, Japanese & English	A
11	24 V AC/DC, English	B
	24 V AC/DC, Chinese & English	D
12	Option	
	None	Y
	Digital input (DI 1, 2, 3)	D
13	RS-485 communication + Digital input (DI1)	V
	—	00

Optional items

Name	Model
Current transformer	1 A to 30A 20 to 100A ZOZ*CCCTL-6-S-H ZOZ*CCCTL-12-S36-8
Terminal cover	ZZPPXR1-A230
Parameter loader interface cable	ZZP*TO501923C3
Shunt resistor (250 Ω±0.1%)	ZZPPXR1-A190
Panel mounting adapter for replacement from PXR7 to PXF4	ZZP*TO502732C1

PXF5 & PXF9 Motorized Valve Control Type

Digit	Specifications	Code
1-4	Front panel size W x H 48 x 96 mm 96 x 96 mm	PXF5 PXF9
5	—	A
6	Control output 1	
	Motorized valve control output (without PFB input) Motorized valve control output (with PFB input)	S V
7	Control output 2	
	None	Y
8	Revision code	2
	Alarm output	
9	None	0
	1 point	1
	2 points	F
	3 points	M
	2 points (independent common)	J
10	Power supply voltage/instruction manual	
	100 to 240 V AC, Japanese & English	Y
	100 to 240 V AC, English	V
	100 to 240 V AC, Chinese & English	W
	24 V AC/DC, Japanese & English	A
11	24 V AC/DC, English	B
	24 V AC/DC, Chinese & English	D
12	Option	
	None	Y
13	RS-485 communication + Digital input (DI1, DI2, DI3)	U
	—	00

Optional items

Name	Model
Current transformer	1 A to 30A 20 to 100A ZOZ*CCCTL-6-S-H ZOZ*CCCTL-12-S36-8
Terminal cover *1	ZZPPXF1-B100
Parameter loader interface cable	ZZP*TO501923C3
Shunt resistor (250 Ω±0.1%)	ZZPPXR1-A190

*1: For PXF9, two covers are necessary for one unit.

Scope of delivery

- Controller × 1
- Panel mounting adapter × 1 set
- Instruction manual × 1
- Water-proof packing × 1

Outline Diagram of Optional Items

Panel mounting adapter for replacement from PXR7 to PXF4 (ZZP*TQ502732C1)

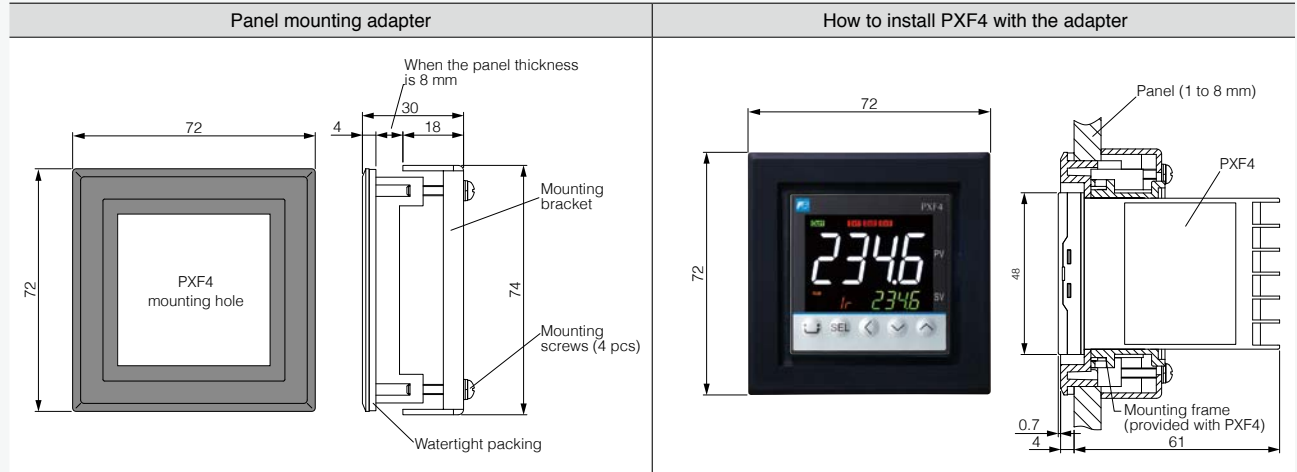

Current transformer (CT)

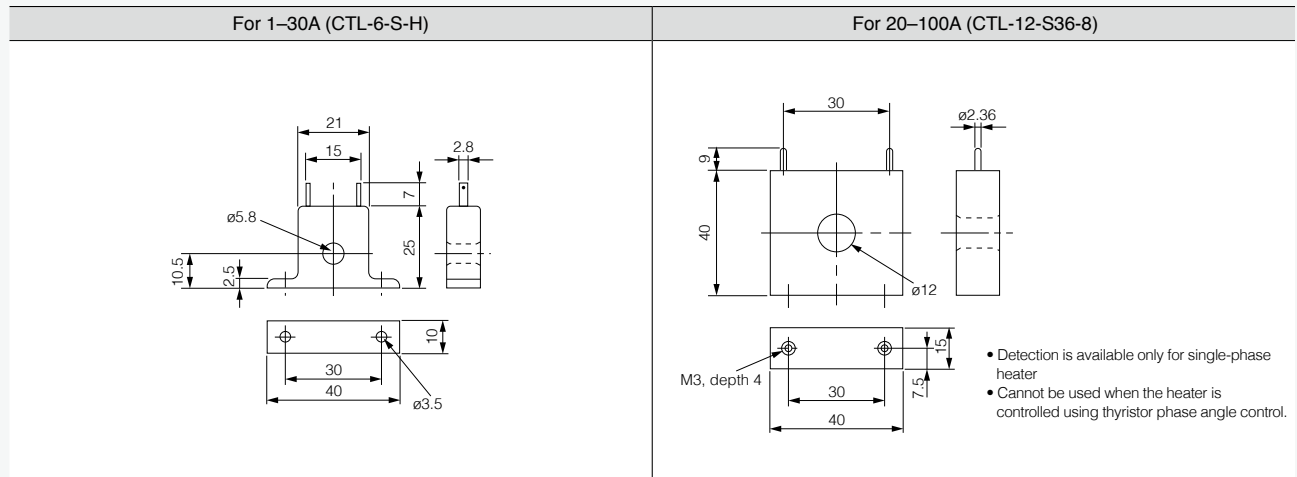

Insulation Block Diagram

PXF4

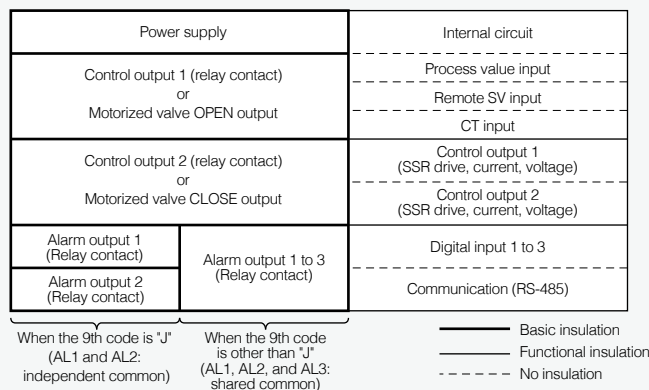

PXF5 and PXF9

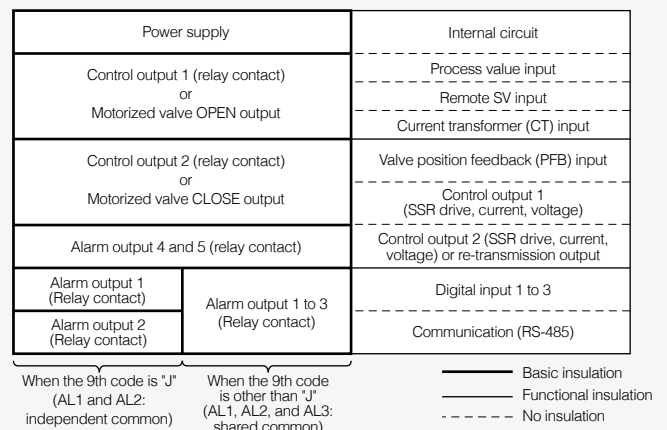

Connection Diagram

Standard type (base model: PXF4)

Control output 1	Relay output (SPST)	Relay output (SPDT)	SSR	Current	Voltage	Relay output (SPST)	Relay output (SPDT)	SSR	Current	Voltage
Control output 2	None	None	None	None	None	Relay output (SPST)	Relay output (SPDT)	Relay output (SPST)	Relay output (SPST)	Relay output (SPST)
Control output 1	SSR	Current	Voltage	SSR	Current	Voltage	SSR	Current	Voltage	
Control output 2	SSR	SSR	SSR	Current or re-transmission output (current)	Current or re-transmission output (current)	Voltage or re-transmission output (voltage)	Voltage or re-transmission output (voltage)	Voltage or re-transmission output (voltage)	Voltage or re-transmission output (voltage)	Voltage or re-transmission output (voltage)

Alarm output

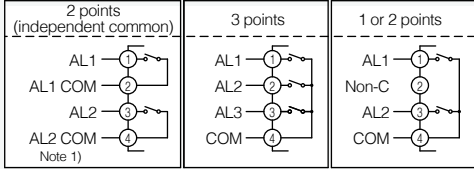

Note 1: Power supplies for AL1 and AL2 must be of the same type, either AC or DC.

Power supply

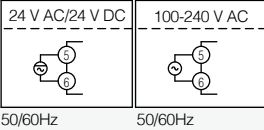

M3 terminals

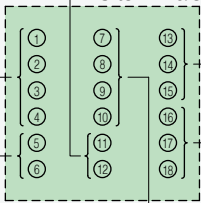

Process value input

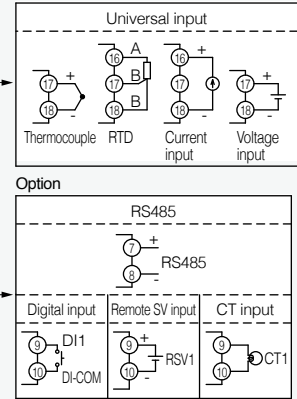

Motorized valve control type (base model: PXF4)

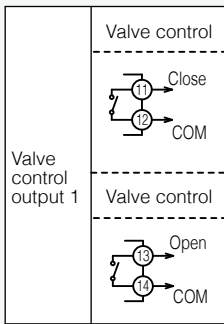

Alarm output

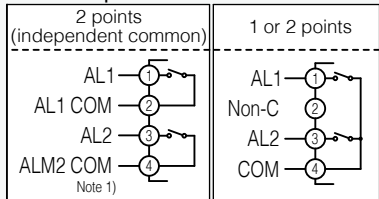

Note 1: Power supplies for AL1 and AL2 must be of the same type, either AC or DC.

Power supply

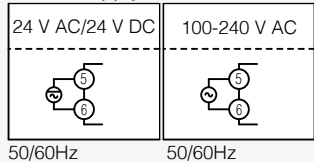

M3 terminals

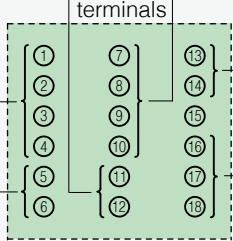

Option

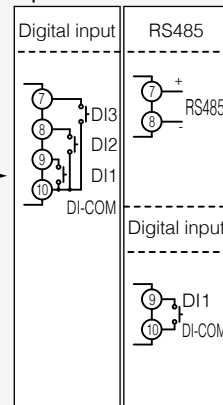

Process value input

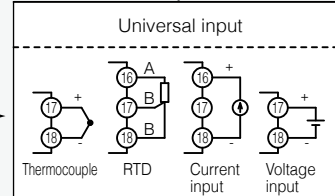

Standard type (base model: PXF5, PXF9)

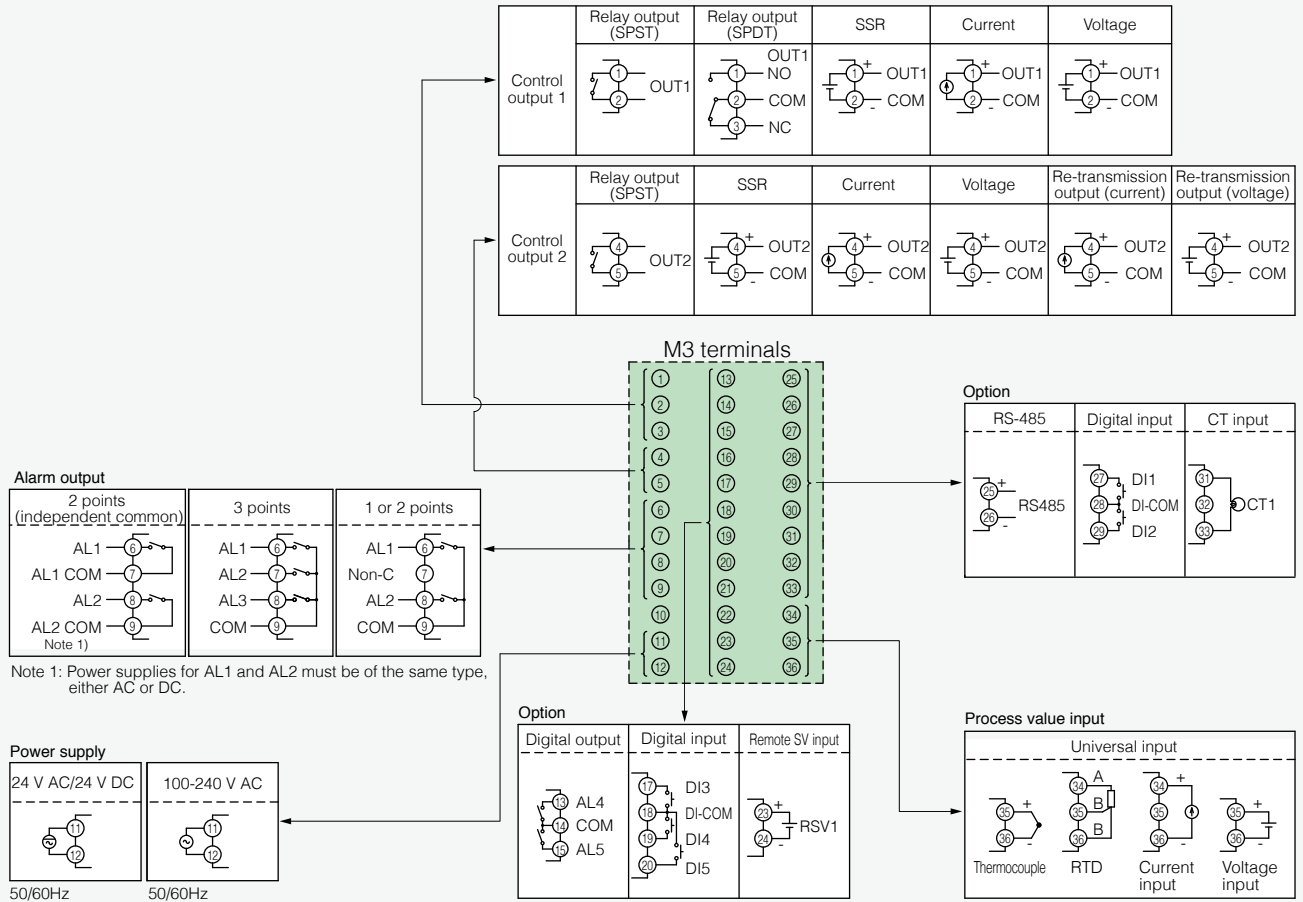

Motorized valve control type (base model: PXF5, PXF9)

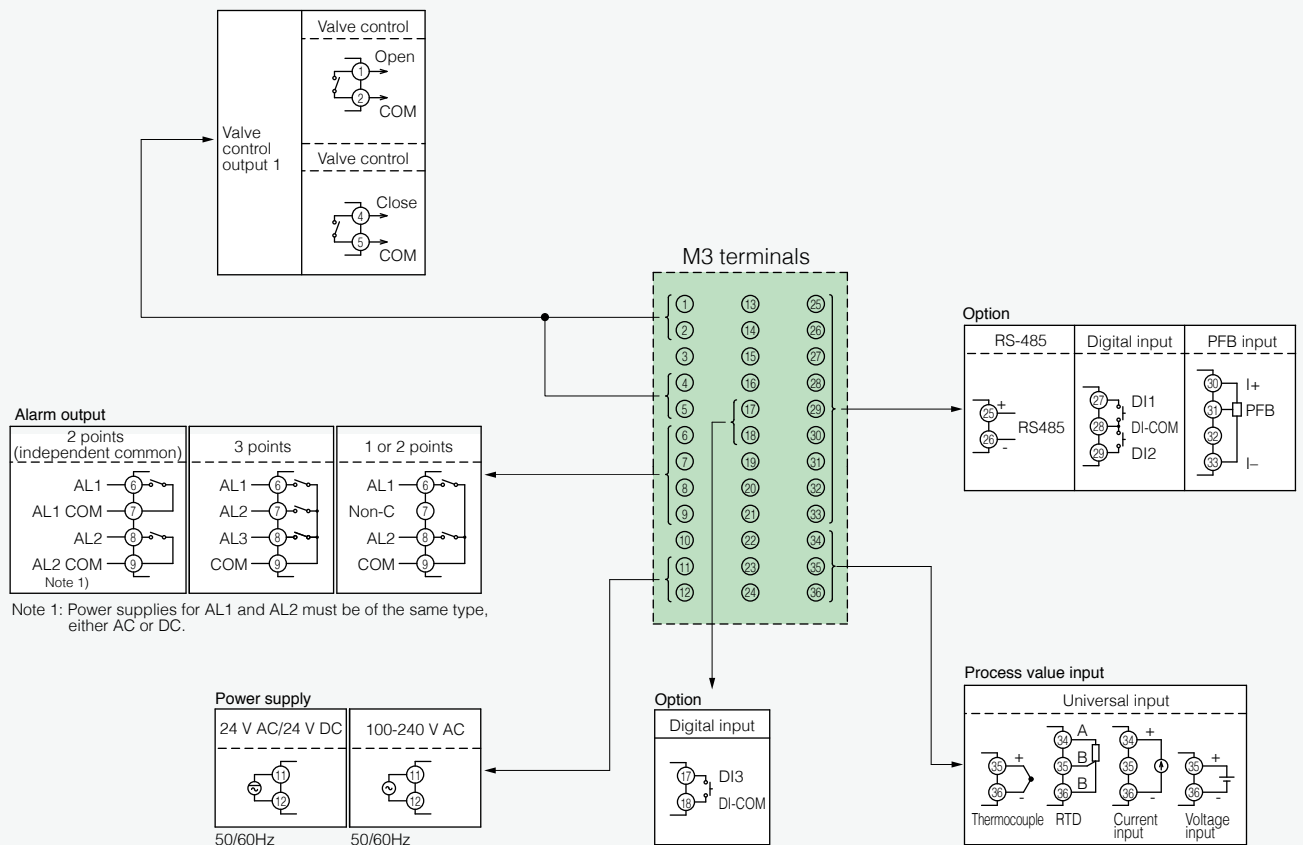

Specifications

General specifications

Power supply voltage	100 V (-15%) to 240 V (+10%) AC, 50/60 Hz, 24 V AC/DC ($\pm 10\%$)		
Power consumption	Model	100 to 240 V AC	24 V DC/AC
	PXF4	10 VA MAX.	5 VA MAX.
	PXF5 & PXF9	13 VA MAX.	8 VA MAX.
Insulation resistance	20 M Ω or more (at 500 V DC)		
Withstand voltage	Power source \leftrightarrow all terminals: 1500 V AC for 1 min Relay contact output \leftrightarrow all terminals: 1500 V AC for 1 min Between others: 500 V AC for 1 min		

Process value input

Number of inputs	1
Input setting	Programmable scale
Input signal	See Table 1 on Page 15. (Universal input: thermocouple/RTD/voltage/current)
Standard measurement range and input type	See Table 1 on Page 15.
Indication accuracy (at $T_a = 23^\circ\text{C}$)	<ul style="list-style-type: none"> Thermocouple input: either $\pm 1^\circ\text{C} \pm 1$ digit or $\pm 0.3\%$ of indicated value ± 1 digit, whichever is larger *except: Thermocouple B: 0 to 400°C: no accuracy assurance Thermocouple R: 0 to 500°C: $\pm 3^\circ\text{C} \pm 1$ digit Thermocouples of which measuring range is between -200°C and -100°C: $\pm 2^\circ\text{C} \pm 1$ digit RTD input: $\pm 0.8^\circ\text{C} \pm 1$ digit or $\pm 0.2\%$ of indication value ± 1 digit, whichever is larger mV input, voltage input, current input: $\pm 0.3\% \text{FS} \pm 1$ digit
Temperature effect on sensitivity	$\pm 0.3\% \text{FS} / 10^\circ\text{C}$
Indication resolution	See Table 1 on Page 15.
Sampling rate	50 ms
Input impedance	<ul style="list-style-type: none"> Thermocouple, mV input: 1 MΩ or more Current input: 150 Ω or less (built-in diode) Voltage input: About 1 MΩ
Variation by signal source resistance	<ul style="list-style-type: none"> Thermocouple, mV input: $\pm 0.3\% \text{FS} \pm 1$ digit per 100 Ω Voltage input: $\pm 0.3\% \text{FS} \pm 1$ digit per 500 Ω
Allowable wiring resistance	<ul style="list-style-type: none"> RTD: 10 Ω MAX. (per wire)
Allowable input voltage:	<ul style="list-style-type: none"> DC voltage input: within ± 35 V Current input: within ± 25 mA Thermocouple, RTD, mV input: within ± 5 V
Noise reduction ratio	Normal mode: 40 dB (50/60 Hz) Common mode: 120 dB (50/60 Hz) Between input and power supply: $\pm 1^\circ\text{C}$ at 220 V AC, 50/60 Hz
Input correction	(a) User adjustment: $\pm 50\% \text{FS}$ for each of zero and span point (b) Process value shift: $\pm 10\% \text{FS}$ (c) Input filter: 0.0 to 120.0 s (filter is off when set to 0.0) (d) Square root extraction: -0.1 to 105% (OFF if set to -0.1%)
Overrange - underrange	Out of the range between -5% and 105% FS (accuracy is not assured between -5 and 0, and between 100 and 105%FS) *except: Pt (-200 $^\circ\text{C}$ to 850 $^\circ\text{C}$) input: } Out of the range between 0 to 10 V DC input: } -2% to 105% of FS Thermocouple E: Out of the range between -5 to 102% of FS

Remote SV input (option)

Number of inputs	1
Input signal	Voltage: 0 to 5 V DC/1 to 5 V DC/0 to 10 V DC Current: 0 to 20 mA DC/4 to 20 mA DC (an external resistance of 250 Ω is required for current input)
Input impedance	Approx. 1 M Ω
Sampling rate	50 ms

Current transformer (CT) input (option)

Input type	Single phase CT, 1 point For 1 A to 30 A: CTL-6-S-H For 20 A to 100 A: CTL-12-S36-8
Range of detected current	1 A to 100A
Detected current accuracy	Setpoint $\pm 5\% \text{FS}$
Detected current resolution	0.1A
ON time necessary for detection	300 ms MIN.

Digital input (DI) (option)

No. of points	PXF5 and PXF9: up to 3 PXF4 standard version: 1 PXF4 motorized valve control version: 3
Specifications	No-voltage contact or transistor input
Contact capacity:	5 V DC, about 2 mA (per point)
Input judgment:	ON voltage: 2 V DC or lower OFF voltage: 3 V DC or higher
Sampling pulse width	50 ms MIN.
Functions	Remote mode selection, SV changeover, control standby, AT startup, timer startup, alarm unlatch, program selection, start/stop/reset, PID switching (normal/reverse), etc.

Valve position feedback signal (potentiometer) input (option)

Model	PXF5 and PXF9 (not available for PXF4)
Resistance range	100 Ω to 2.5k Ω , three-wire
Resolution	0.5% FS
Accuracy	$\pm 1.0\% \text{FS}$
Temperature effect on sensitivity	$\pm 0.5\% \text{FS} / 10^\circ\text{C}$
Burnout function	None

Control output

No. of points	Up to 2 (2 points: Heating/cooling control)
Type	1. Relay contact output (SPST) <ul style="list-style-type: none"> Proportional cycle: 1 to 150 s Contact structure: 1 SPST contact *SPST: single pole single throw Contact capacity: 250 V AC/30 V DC, 3A (resistive load) Minimum ON/OFF current: 10 mA (5 V DC) Mechanical life: 20 million operations MIN. (100 operations/min) Electrical life: 100,000 operations MIN. (rated load) 2. Relay contact output (SPDT) <ul style="list-style-type: none"> Proportional cycle: 1 to 150 s Contact structure: 1 SPDT contact *SPDT: single pole double t row Contact capacity: 250 V AC/30 V DC, 5A (resistive load) Mechanical life: 50 million operations MIN. (100 operations/min) Electrical life: 100,000 operations MIN. (rated load) 3. SSR/SSC drive output <ul style="list-style-type: none"> Proportional cycle: 1 to 150 s ON voltage: 12 V DC (between 10.7 and 13.2 V DC) OFF voltage: 0.5 V DC or lower Maximum current: 20 mA DC Load resistance: 600 Ω MIN. 4. Current output (0 to 20 mA DC/4 to 20 mA DC) <ul style="list-style-type: none"> Accuracy: $\pm 5\% \text{FS}$ Load resistance: 500 Ω MAX. 5. Voltage output (0 to 5 V DC/1 to 5 V DC/0 to 10 V DC/2 to 10 V DC) <ul style="list-style-type: none"> Accuracy: $\pm 5\% \text{FS}$ Load resistance: 10 kΩ MIN. 6. Motorized valve control output <ul style="list-style-type: none"> Contact structure: 2 SPST contacts without interlock circuit *SPST: Single Pole Single Throw Contact capacity: 250 V AC/30 V DC, 3A (resistive load) Minimum ON/OFF current: 100 mA (24 V DC) Mechanical life: 20 million operations MIN. (100 operations/min) Electrical life: 100,000 operations MIN. (rated load)
Select among 1 to 6	

Alarm output (DO) (option)

Number of outputs	Relay contact Shared COM: PXF5 & PXF9: ≤ 5 , PXF4: ≤ 3 Independent COM: PXF5 & PXF9: ≤ 3 , PXF4: ≤ 2
Output specifications	Relay contact output <ul style="list-style-type: none"> Contact structure: SPST *SPST: single pole single throw Contact capacity: 250 V AC/30 V DC, 1A (resistive load) Minimum ON/OFF current: 10 mA (5 V DC) Mechanical life: 20 million operations MIN. (100 operations/min) Electrical life: 100,000 operations MIN. (rated load)
Output functions	Alarm output (see *Alarm function*), main unit control mode output, program status output, control output 1 and 2, etc.
Output cycle	100 ms

Re-transmission output (option)

No. of points	1
Type	Current/voltage output (0 to 20 mA DC/4 to 20 mA DC/0 to 5 V DC/1 to 5 V DC/0 to 10 V DC/2 to 10 V DC) <ul style="list-style-type: none"> Guaranteed output range: 0 to 21 mA DC/0 to 10.5 V DC Accuracy: $\pm 0.2\% \text{FS}$ ($\pm 5\% \text{FS}$ at 1 mA or smaller) Resolution: 10,000 MIN. Load resistance: 500 Ω MAX. (current), 10 kΩ MIN. (voltage)
Output cycle	100 ms
Output contents	PV, SV, DV, MV
Additional function	Scaling function

Display and keys

Type	LCD (with backlight)
Indication contents	Process value indication: 11-segment, 4-digit [white] Setpoint indication: 11-segment, 4-digit [green] Screen No. indication: 7-segment, 4-digit [orange] Status indication: 42 indicator lamps
Luminance setting	possible (4 steps)
Keys	Sheet type keys (with emboss), 5 keys

Control functions

ON/OFF control	Refer to page 4.
PID control	<ul style="list-style-type: none"> Dual control (heating/cooling) PID parameters determination: Auto tuning
Fuzzy PID control	<ul style="list-style-type: none"> Dual control (heating/cooling) PID parameters determination: Auto tuning
Self tuning control	Refer to page 5.
PID2 control	<ul style="list-style-type: none"> Dual control (heating/cooling) PID parameters determination: Auto tuning
2-degrees-of-freedom PID	<ul style="list-style-type: none"> PID parameters determination: Auto tuning
Position proportional PID (servo) with position feedback	<ul style="list-style-type: none"> Full stroke time: 30 seconds MIN. (not available for PXF4)

Control parameters

Proportional band (P)	0.1% to 999.9%
Integration time (I)	0 to 3200 s (invalidated when I = 0)
Differential time (D)	0.0 to 999.9 s (invalidated when D = 0)
Control cycle	100 to 900 ms (in 100 ms), 1 to 99 s (in seconds)
Anti-reset windup	0 to 100% of measurement range
Hysteresis band	50% of measurement range (at 2-position control only)
Number of SV and PID patterns	8: Changed by any of parameter setting, digital input, communication, user function keying, zone change.

Control mode

Mode	Auto/Manual/Remote *During 2-position control in Manual mode, 2-position manual operation with MV = 100% or 0% is operated.
Mode changeover:	<ul style="list-style-type: none"> Auto ↔ Manual: Balanceless · bumpless Auto/Manual → Remote: Balance · bumpless Auto/Manual ← Remote: Balance · bumpless

Alarm

Number of alarm	Up to 5 (depends on the number of DO)
Alarm type	Process value (upper limit/lower limit, absolute/deviation, range), main unit error, etc.(non-excitation, delay, latch, timer function option provided)
Heater current alarm function (option)	Current transformer (CT) is to be prepared separately (see page 10.)
Detectable range	1 A to 100 A
Detected current resolution	0.1A
Setting resolution	0.1A
Hysteresis	0.0 to 100.0 A

RS-485 communication (option)

No. of points	1 point
Physical specifications	EIA-485
Protocol	Modbus-RTU
Communication method	Half-duplex bit serial, asynchronous communication
Code type	Data length: 8 data bits. Parity: Odd, even, none.
Baud rate	9600 bps, 19200 bps, 38.4 kbps, 115.2 kbps
Connection	Up to 32 units
Communication distance	Up to 500 m (total connection length)
Additional function	<ul style="list-style-type: none"> Multidrop master function The function in which slave devices can be operated by a master device by connecting several temperature controllers. Programless communication The function in which a temperature controller can be connected to a PLC without program. Supported PLCs: Mitsubishi PLC Q series Siemens PLC S7 series

Operation and storage conditions

Operating temperature	-10°C to 50°C
Storage temperature	-20°C to 60°C
Operating/storage humidity	90%RH or less (Non condensation)
Warm-up time	30 min MIN.
Vibration	during transportation: 9.8 m/s ² (1 G) or less
Impact	during transportation: 294m/s ² (30 G) or less

Enclosure

Installation	Panel mount
External terminals	Screw terminals, M3
Case	<ul style="list-style-type: none"> Material: ABS, PPO Non-combustibility grade: UL94V-0 equivalent Color: Black
Protection structure	<ul style="list-style-type: none"> Panel front side: IP66, NEMA-4X equivalent (When the panel is mounted using our genuine packing. Not water-proof if mounted closely together.) Body: IP20 equivalent (slits on top and bottom) Terminals: IP00 equivalent. Terminal cover can be mounted optionally.
Dimensions	Refer to page 9.
Weight	PXF4: approx. 100 g, PXF5: approx. 170 g, PXF9: approx. 220 g

Customizable function and Program (ramp/soak) function

Number of program steps:	64 steps × 1 pattern, 32 steps × 2 patterns, 16 steps × 4 patterns, or 8 steps × 8 patterns (1 step = 2 segments)
Control option	Control by digital input Status output by digital output
Basic functions	<ol style="list-style-type: none"> Segment time can be set in "Hour, Minutes" or "Minutes, Seconds" Guarantee soak Repeat action PV start Delay start Power restoring function
Memory backup	EEPROM

User key

Assignable functions	Auto/Manual change, Standby ON/OFF change, remote SV change, ramp/soak change, etc.
----------------------	---

Password function

3-level password

Simple watt-hour metering function and operating days alarm

Simple watt-hour metering function	<ul style="list-style-type: none"> By connecting a current transformer (to be prepared separately), electric power consumption of the heater can be displayed. (Electric power is calculated based on the fixed voltage value you set.) Current transformer (CT) is to be prepared separately (see page 10.) Current detection range: 1 A to 100 A
Operating days alarm	<ul style="list-style-type: none"> Indicates the number of days the controller has been operated and activates alarm output (optional) when it exceeds the setpoint. Useful for preventive maintenance because it let you know the appropriate time for maintenance work.

Data backup at power outage

on non-volatile memory

Self-diagnosis

Program error supervision by watchdog timer

Table 1 input type and range

Input type	Code (PvT)	Measurement range [°C]	Minimum input increment [°C]	
RTD	Pt 100	PT1	0.0 to 150.0	0.1
		PT2	0.0 to 300.0	0.1
		PT3	0.0 to 500.0	0.1
		PT4	0.0 to 600.0	0.1
		PT5	-50.0 to 100.0	0.1
		PT6	-100.0 to 200.0	0.1
		PT7	-199.9 to 600.0	0.1
		PT8	-200 to 850	1
DC voltage	0 to 5 V DC	0-5V	-1999 to 9999 (Range where scaling is allowed)	-
	1 to 5 V DC	1-5V		
	0 to 10V DC	0-10		
	2 to 10V DC	2-10		
DC current	0 to 100mV DC	MV		
	0 to 20 mA DC	0-20		
	4 to 20 mA DC	4-20		

Input type	Code (PvT)	Measurement range [°C]	Minimum input increment [°C]	
Thermocouple	J	J1	0.0 to 400.0	0.1
		J2	-20.0 to 400.0	0.1
		J3	0.0 to 800.0	0.1
		J4	-100 to 1000	1
	K	K1	0 to 400	0.1
		K2	-20.0 to 500.0	0.1
		K3	0.0 to 800.0	0.1
		K4	-200 to 1300	1
	R	R	0 to 1700	1
	B	B	0 to 1800	1
	S	S	0 to 1700	1
	T	T1	-199.9 to 200.0	0.1
		T2	-199.9 to 400.0	0.1
	E	E1	0.0 to 800.0	0.1
		E2	-150.0 to 800.0	0.1
		E3	-200 to 800	1
L	L	-100 to 850	1	
U	U1	-199.9 to 400.0	0.1	
	U2	-200 to 400	1	
N	N	-200 to 1300	1	
W	W	0 to 2300	1	
PL-II	PL-2	0 to 1300	1	

MSA CONTROL Indústria Elétrica Ltda.
MSA SYSTEM Elétrica Ltda.

Rua Iapó 334 - Casa Verde - São Paulo - SP - CEP:02512.02

Tel/Fax: (11) 3961.1171 - comercial@msacontrol.com.br

www.msasystemelectric.com.br & www.msacontrol.com.br

Please read the following instructions carefully before operating the Digital Temperature Controller



Over-Temperature Protection

Any control system design should take into account that any part of the system has the potential to fail.

For temperature control systems, continued heating should be considered the most dangerous condition, and the machine should be designed to automatically stop heating if unregulated due to the failure of the control unit or for any other reason.

The following are the most likely causes of unwanted continued heating:

- 1) Controller failure with heating output constantly on
- 2) Disengagement of the temperature sensor from the system
- 3) A short circuit in the thermocouple wiring
- 4) A valve or switch contact point outside the system is locked to keep the heat switched on.

In any application where physical injury or destruction of equipment might occur, we recommend the installation of independent safety equipment, with a separate temperature sensor, to disable the heating circuit in case of overheating.

The controller alarm signal is not designed to function as a protective measure in case of controller failure.

⚠ Caution on Safety

* Before using products in this catalog, be sure to read their instruction manuals in advance.

 **Fuji Electric Co., Ltd.**